

TYPICAL ELEVATION WITH FASTENER SPACING

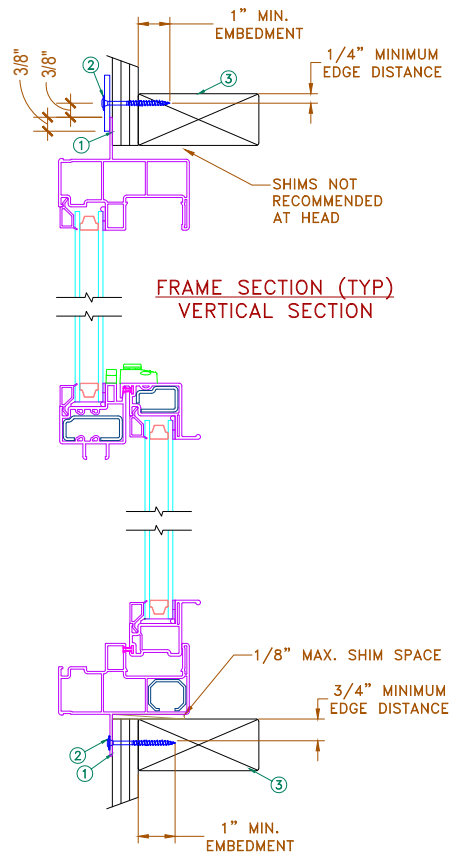

FRAME SECTION (TYP)
VERTICAL SECTION

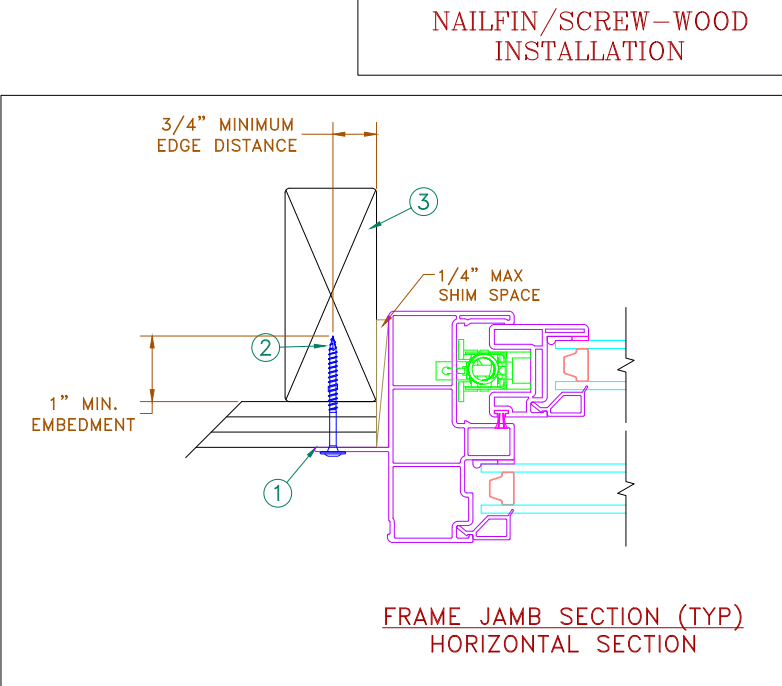

FRAME JAMB SECTION (TYP)
HORIZONTAL SECTION

NAILFIN/SCREW - WOOD
INSTALLATION

MAXIMUM FRAME	CLASS/DP	IMPACT
144" x 96"	CW/30	NO

Installation Notes:

- Seal flange/frame to substrate. Sill shall be set on a continuous serpentine bead of structural grade silicone/caulk.
- Head fastener size is minimum #8 pan head / truss head and must be fastened, beginning 4" - 6" from welded corners, then every 4" O.C. using fender washers lapped over nailing flange a minimum of 3/8", leaving a minimum of 3/8" gap between shaft of fastener and edge of nailing flange. Jamb and Sill fastener size is minimum #8 pan head / truss head and must be fastened, beginning 4"-6" from welded corners, then every hole and must penetrate structural framing a minimum of 1" in depth. (For 2X wood frame substrate, MIN S.G. = 0.42)
- Structural framing (wood buck, stud framing and opening) to be designed and anchored to properly transfer all loads to structure. The host structure is the responsibility of the architect or engineer of the record for the project of installation

General Notes:

- The product shown herein is designed, tested and manufactured to comply with the wind load criteria of the adopted International Building Code (IBC), the International Residential Code (IRC), the current Florida Building Code (FBC) and the industry requirement for the stated conditions.
- All glazing shall conform to ASTM E1300.
- At minimum, glazing shall be 3mm annealed - 13mm airspace - 3mm annealed glass.
- Use structural or composite shims where required.

This item has been digitally signed and sealed by Micah Swartz, P.E. on the date adjacent to the seal.
Printed copies of this document are not considered signed and sealed and the signature must be verified on any electronic copies

This schedule addresses only the fasteners required to anchor the unit to achieve the rated design pressure and impact performance (where applicable) up to the size limitations noted. It is not intended as a guide to the installation process and does not address the sealing consideration that may arise in different wall conditions. For the complete installation procedure, see the instructions packaged with the unit or go to www.jeld-wen.com.

DISCLAIMER:
This drawing and its contents are confidential and are not to be reproduced or copied in whole or in part or used or disclosed to others except as authorized by JELD-WEN Inc.

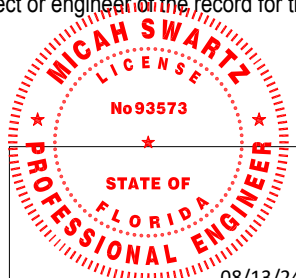

08/13/24
MICAH SWARTZ, P.E.
PE No. 93573
5134 Cambridge Ct.
Klamath Falls, OR 97603
(541) 363-8075

DRAWN	bpoutre	07/30/2024
CHECKED		
APPROVED		
SIZE	B	SCALE NTS SHEET 1 of 8
PRODUCT FAMILY	591 ENDURANCE	
DRAWING ID NO.	184-1	



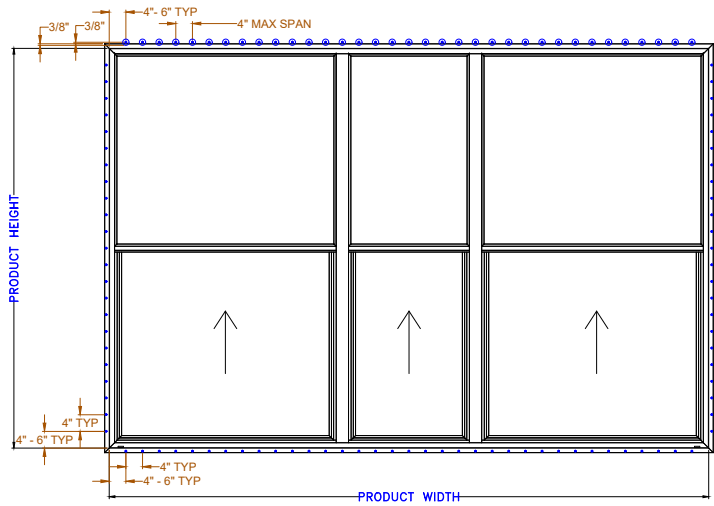

TYPICAL ELEVATION WITH FASTENER SPACING

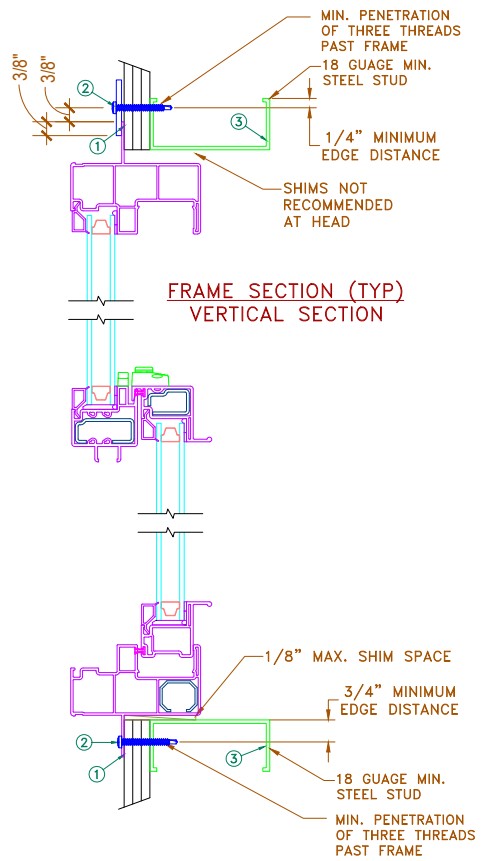

FRAME SECTION (TYP) VERTICAL SECTION

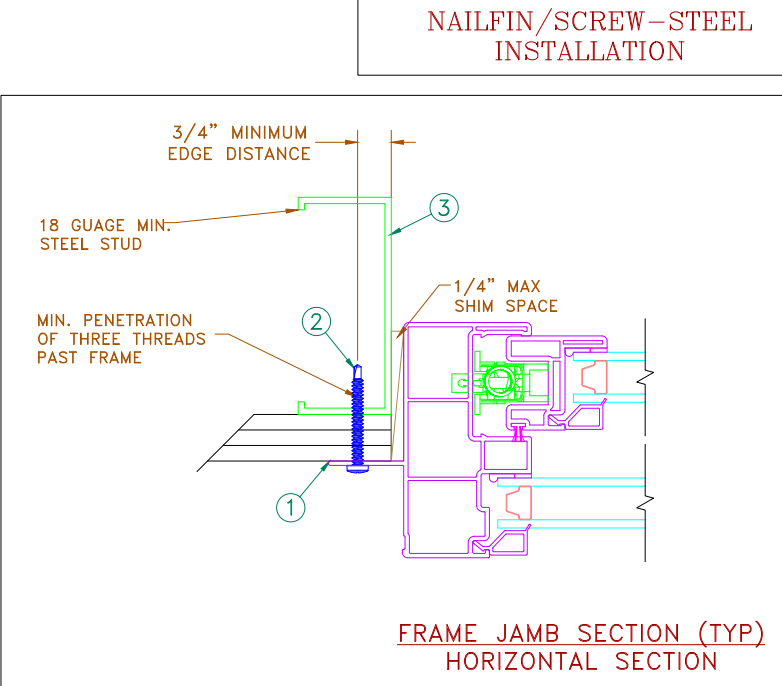

FRAME JAMB SECTION (TYP) HORIZONTAL SECTION

MAXIMUM FRAME	CLASS/DP	IMPACT
144" x 96"	CW/30	NO

Installation Notes:

1. Seal flange/frame to substrate. Sill shall be set on a continuous serpentine bead of structural grade silicone/caulk.
2. Head fastener size is minimum #10 TEK Screw and must be fastened, beginning 4" - 6" from welded corners, then every 4" O.C. using fender washers lapped over nailing flange a minimum of 3/8", leaving a minimum of 3/8" gap between shaft of fastener and edge of nailing flange. Jamb and Sill fastener size is minimum #10 TEK Screw and must be fastened, beginning 4"-6" from welded corners, then every hole and must penetrate structural framing a minimum of 3 threads past framing MIN Fy = 33 KSI.
3. Structural framing (wood buck, stud framing and opening) to be designed and anchored to properly transfer all loads to structure. The host structure is the responsibility of the architect or engineer of the record for the project of installation

General Notes:

1. The product shown herein is designed, tested and manufactured to comply with the wind load criteria of the adopted International Building Code (IBC), the International Residential Code (IRC), the current Florida Building Code (FBC) and the industry requirement for the stated conditions.
2. All glazing shall conform to ASTM E1300.
3. At minimum, glazing shall be 3mm annealed - 13mm airspace - 3mm annealed glass.
4. Use structural or composite shims where required.

This item has been digitally signed and sealed by Micah Swartz, P.E. on the date adjacent to the seal.

Printed copies of this document are not considered signed and sealed and the signature must be verified on any electronic copies

This schedule addresses only the fasteners required to anchor the unit to achieve the rated design pressure and impact performance (where applicable) up to the size limitations noted. It is not intended as a guide to the installation process and does not address the sealing consideration that may arise in different wall conditions. For the complete installation procedure, see the instructions packaged with the unit or go to www.jeld-wen.com.

DISCLAIMER:
This drawing and its contents are confidential and are not to be reproduced or copied in whole or in part or used or disclosed to others except as authorized by JELD-WEN Inc.

MICAH SWARTZ, P.E.
PE No. 93573
5134 Cambridge Ct.
Klamath Falls, OR 97603
(541) 363-8075

DRAWN	bpoutre	07/30/2024
CHECKED		
APPROVED		
SIZE	B	SCALE NTS SHEET 2 of 8
PRODUCT FAMILY	591 ENDURANCE	
DRAWING ID NO.	184-2	



MASONRY STRAP
WOOD/SCREW INSTALLATION

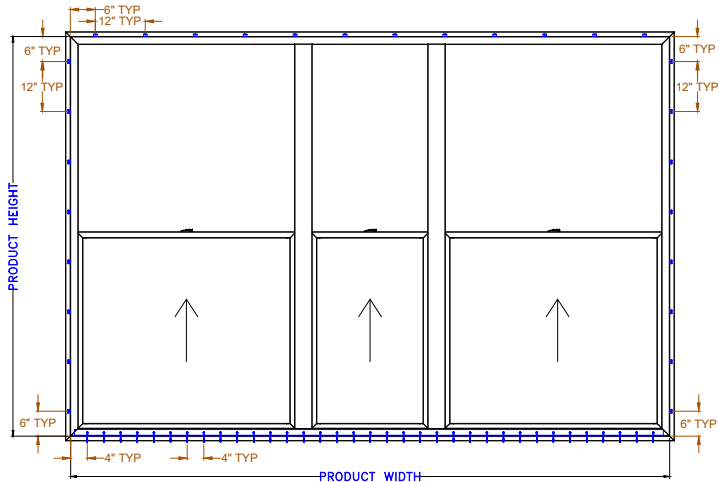

TYPICAL ELEVATION WITH FASTENER SPACING

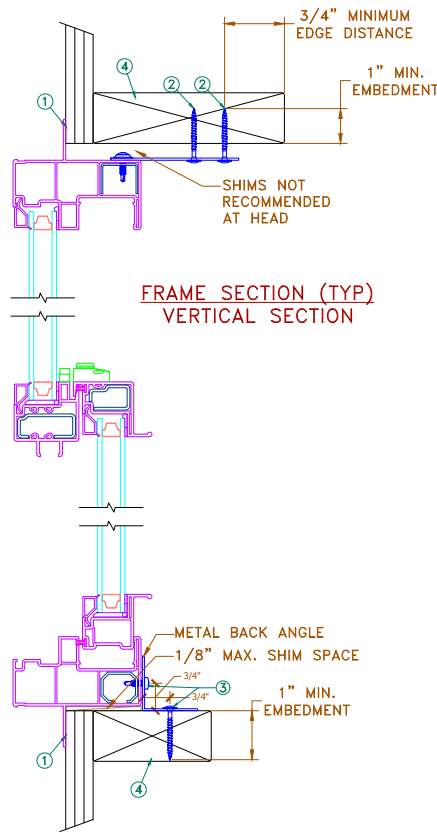

FRAME SECTION (TYP)
VERTICAL SECTION

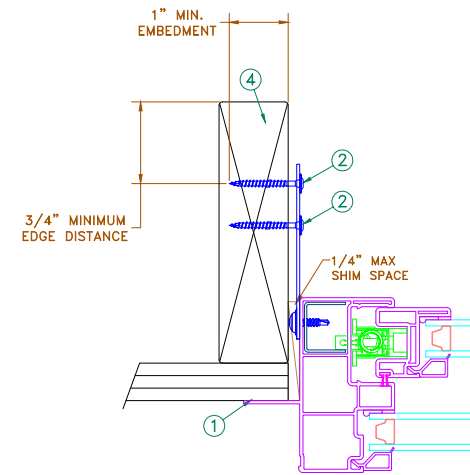

FRAME JAMB SECTION (TYP)
HORIZONTAL SECTION

MAXIMUM FRAME	CLASS/DP	IMPACT
144" x 96"	CW/30	NO

Installation Notes:

1. Seal flange/frame to substrate. Sill shall be set on a continuous serpentine bead of structural grade silicone/caulk.
2. Head and Jamb must be fastened through anchor strap using (QTY 2) #10 Fasteners with sufficient length to penetrate a Min. 1" into wood substrate. (For 2x wood frame substrate, Min. S.G. = 0.42).
3. Sill fastener size @ back angle to wood framing is #8 @ 4" O.C. Fastener size for sill @ back angle to window is 10-16 TEK Screw @ 4" O.C.
4. Structural framing (wood buck, stud framing and opening) to be designed and anchored to properly transfer all loads to structure. The host structure is the responsibility of the architect or engineer of the record for the project of installation

General Notes:

1. The product shown herein is designed, tested and manufactured to comply with the wind load criteria of the adopted International Building Code (IBC), the International Residential Code (IRC), the current Florida Building Code (FBC) and the industry requirement for the stated conditions.
2. Nail flange is optional, and used for a weather seal only.
3. All glazing shall conform to ASTM E1300.
4. At minimum, glazing shall be 3mm annealed - 13mm airspace - 3mm annealed glass.
5. Use structural or composite shims where required.
6. Anchor strap specifications: 16 Ga. galvanized steel, .060 min. thickness x .850" width.
7. Sill metal back angle material is either Aluminum 1/8" Min. or Steel 16 Ga. Min.

This item has been digitally signed and sealed by Micah Swartz, P.E. on the date adjacent to the seal.

Printed copies of this document are not considered signed and sealed and the signature must be verified on any electronic copies

This schedule addresses only the fasteners required to anchor the unit to achieve the rated design pressure and impact performance (where applicable) up to the size limitations noted. It is not intended as a guide to the installation process and does not address the sealing consideration that may arise in different wall conditions. For the complete installation procedure, see the instructions packaged with the unit or go to www.jeld-wen.com.

DISCLAIMER:

This drawing and its contents are confidential and are not to be reproduced or copied in whole or in part or used or disclosed to others except as authorized by JELD-WEN Inc.

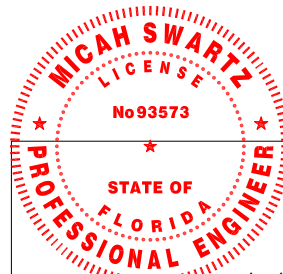

08/13/24
MICAH SWARTZ, P.E.
PE No. 93573
5134 Cambridge Ct.
Klamath Falls, OR 97603
(541) 363-8075

DRAWN	Bpoutre	07/30/2024
CHECKED		
APPROVED		
SIZE	B	SCALE NTS SHEET 3 of 8
PRODUCT FAMILY	591 ENDURANCE	
DRAWING ID NO.	184-3	



MASONRY STRAP STEEL/SCREW INSTALLATION

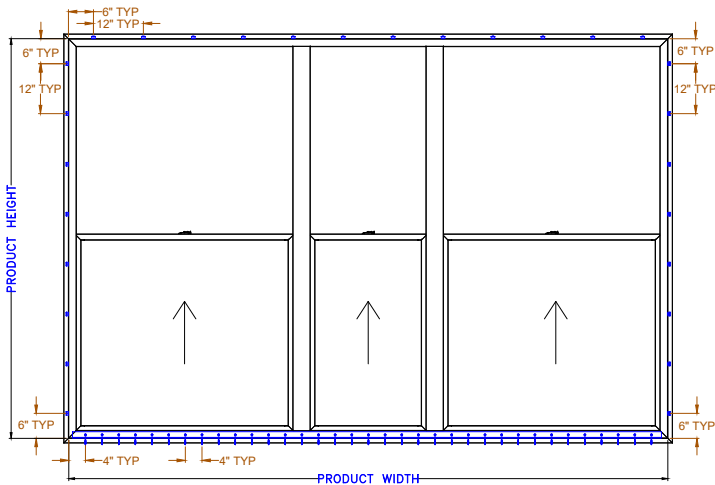

TYPICAL ELEVATION WITH FASTENER SPACING

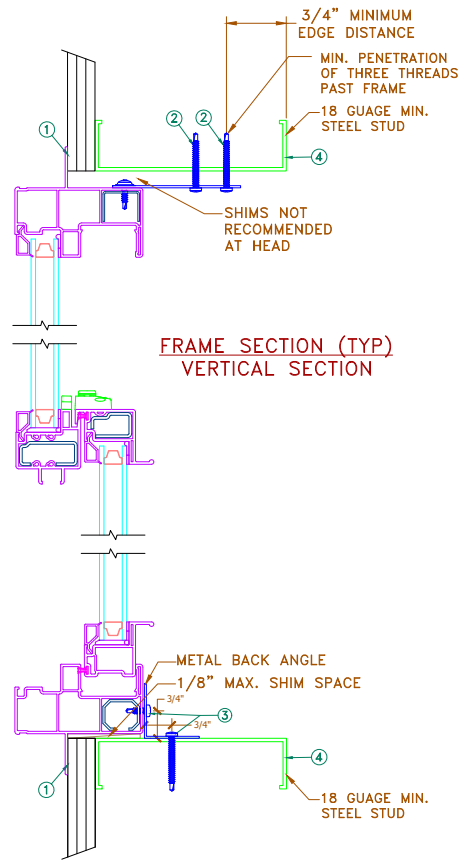

FRAME SECTION (TYP)
VERTICAL SECTION

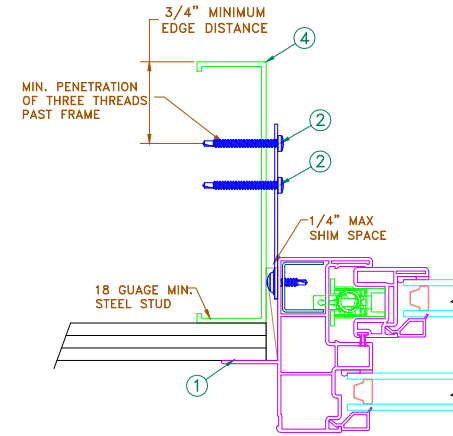

FRAME JAMB SECTION (TYP)
HORIZONTAL SECTION

MAXIMUM FRAME	CLASS/DP	IMPACT
144" x 96"	CW/30	NO

Installation Notes:

1. Seal flange/frame to substrate. Sill shall be set on a continuous serpentine bead of structural grade silicone/caulk.
2. Head and Jamb must be fastened through anchor strap using (QTY 2) #10 TEK Screws MIN. Fy = 33 KSI
3. Sill fastener size @ back angle to steel framing is 10-16 TEK Screw @ 4" O.C.. Fasteners must penetrate structural framing a minimum of 3 threads past framing. Fastener size for sill @ back angle to window is #8 x 1/2"(MAX.) @ 4" O.C.
4. Structural framing (wood buck, stud framing and opening) to be designed and anchored to properly transfer all loads to structure. The host structure is the responsibility of the architect or engineer of the record for the project of installation

General Notes:

1. The product shown herein is designed, tested and manufactured to comply with the wind load criteria of the adopted International Building Code (IBC), the International Residential Code (IRC), the current Florida Building Code (FBC) and the industry requirement for the stated conditions.
2. Nail flange is optional, and used for a weather seal only.
3. All glazing shall conform to ASTM E1300.
4. At minimum, glazing shall be 3mm annealed - 13mm airspace - 3mm annealed glass.
5. Use structural or composite shims where required.
6. Anchor strap specifications: 16 Ga. galvanized steel, .060 min. thickness x .850" width.
7. Sill metal back angle material is either Aluminum 1/8" Min. or Steel 16 Ga. Min.

This item has been digitally signed and sealed by Micah Swartz, P.E. on the date adjacent to the seal.

Printed copies of this document are not considered signed and sealed and the signature must be verified on any electronic copies

This schedule addresses only the fasteners required to anchor the unit to achieve the rated design pressure and impact performance (where applicable) up to the size limitations noted. It is not intended as a guide to the installation process and does not address the sealing consideration that may arise in different wall conditions. For the complete installation procedure, see the instructions packaged with the unit or go to www.jeld-wen.com.

DISCLAIMER:

This drawing and its contents are confidential and are not to be reproduced or copied in whole or in part or used or disclosed to others except as authorized by JELD-WEN Inc.

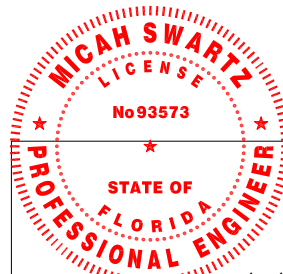

08/13/24
MICAH SWARTZ, P.E.
PE No. 93573
5134 Cambridge Ct.
Klamath Falls, OR 97603
(541) 363-8075

DRAWN	Bpoutre			07/30/2024
CHECKED				
APPROVED				
SIZE	B	SCALE	NTS	SHEET 4 of 8
PRODUCT FAMILY	591 ENDURANCE			
DRAWING ID NO.	184-4			



MASONRY STRAP CONCRETE SCREW INSTALLATION

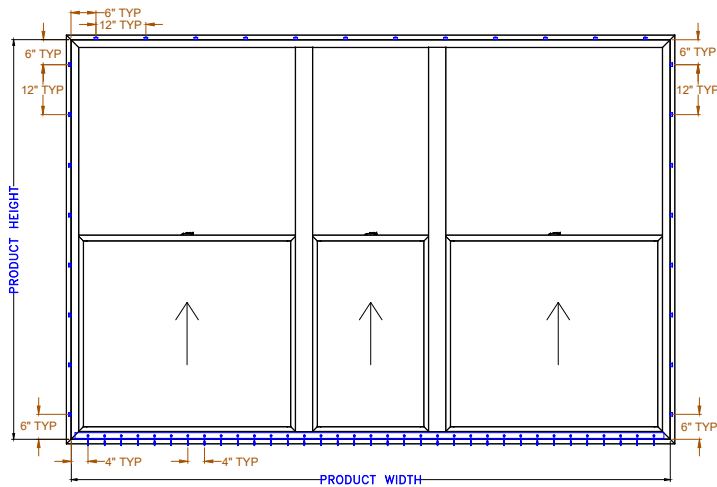

TYPICAL ELEVATION WITH FASTENER SPACING

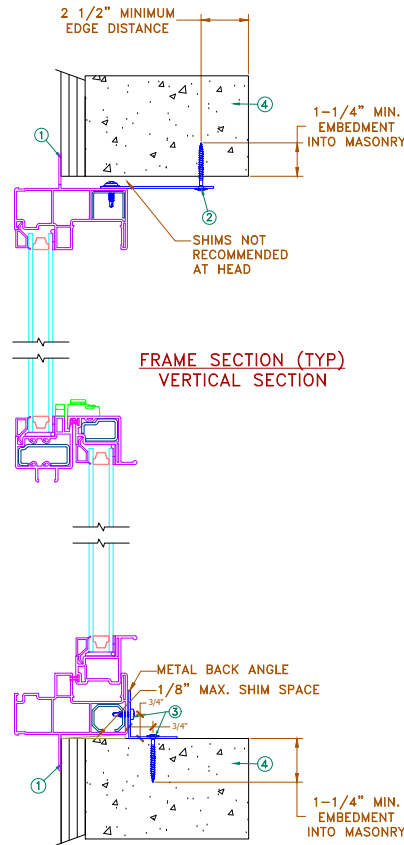

FRAME SECTION (TYP)
VERTICAL SECTION

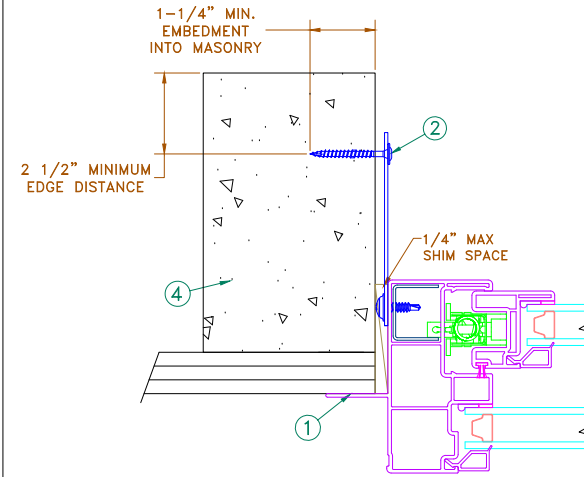

FRAME JAMB SECTION (TYP)
HORIZONTAL SECTION

MAXIMUM FRAME	CLASS/DP	IMPACT
144" x 96"	CW/30	NO

Installation Notes:

- Seal flange/frame to substrate. Sill shall be set on a continuous serpentine bead of structural grade silicone/caulk.
- Head and Jamb must be fastened through anchor strap using one (1) 1/4"Ø Tapcon or equivalent fastener through masonry strap with sufficient length to penetrate a minimum of 1-1/4" into masonry substrate with a 2-1/2" minimum edge distance. CMU shall adhere to ASTM C90 and concrete shall have a min. F'c=3,000 PSI.
- Sill fastener to be 3/16" Tapcon @ 4" O.C. through back angle with sufficient length to penetrate 1-1/4" into masonry substrate with a 2-1/2" min. edge distance. CMU shall adhere to ASTM C90 and concrete shall have a Min. F'c=3,000 PSI. Fastener size for sill @ back angle to window is 10-16 x 1/2"(MAX.) TEK Screw @ 4" O.C.
- Structural framing (wood buck, stud framing and opening) to be designed and anchored to properly transfer all loads to structure. The host structure is the responsibility of the architect or engineer of the record for the project of installation

General Notes:

- The product shown herein is designed, tested and manufactured to comply with the wind load criteria of the adopted International Building Code (IBC), the International Residential Code (IRC), the current Florida Building Code (FBC) and the industry requirement for the stated conditions.
- Nail flange is optional, and used for a weather seal only.
- All glazing shall conform to ASTM E1300.
- At minimum, glazing shall be 3mm annealed - 13mm airspace - 3mm annealed glass.
- Use structural or composite shims where required.
- Anchor strap specifications: 16 Ga. galvanized steel, .060 min. thickness x .850" width.
- Sill metal back angle material is either Aluminum 1/8" Min. or Steel 16 Ga. Min.

This item has been digitally signed and sealed by Micah Swartz, P.E. on the date adjacent to the seal.

Printed copies of this document are not considered signed and sealed and the signature must be verified on any electronic copies

This schedule addresses only the fasteners required to anchor the unit to achieve the rated design pressure and impact performance (where applicable) up to the size limitations noted. It is not intended as a guide to the installation process and does not address the sealing consideration that may arise in different wall conditions. For the complete installation procedure, see the instructions packaged with the unit or go to www.jeld-wen.com.

DISCLAIMER:

This drawing and its contents are confidential and are not to be reproduced or copied in whole or in part or used or disclosed to others except as authorized by JELD-WEN Inc.

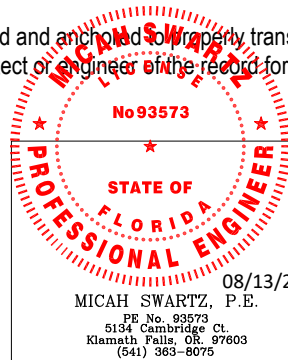

DRAWN	Bpoutre			08/12/2024
CHECKED				
APPROVED				
SIZE	B	SCALE	NTS	SHEET 5 of 8
PRODUCT FAMILY	591 ENDURANCE			
DRAWING ID NO.	184-5			



NO FLANGE/MASONRY STRAP
WOOD/SCREW INSTALLATION

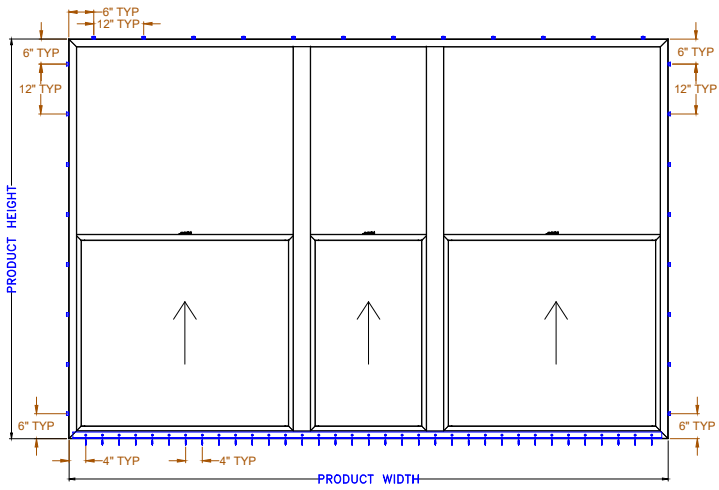

TYPICAL ELEVATION WITH FASTENER SPACING

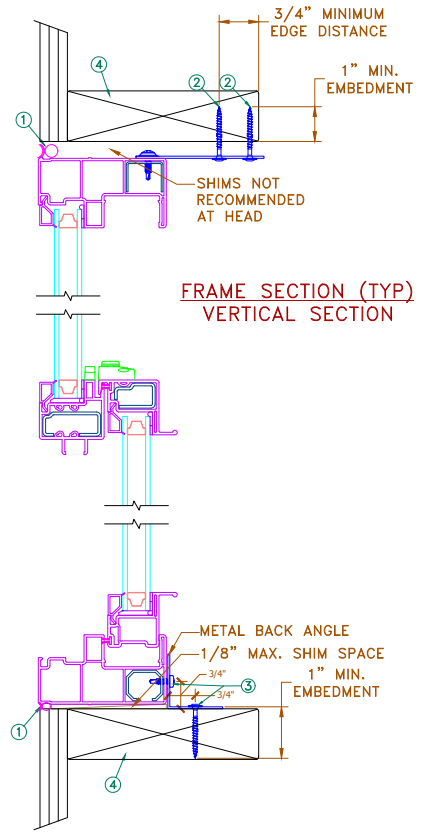

FRAME SECTION (TYP)
VERTICAL SECTION

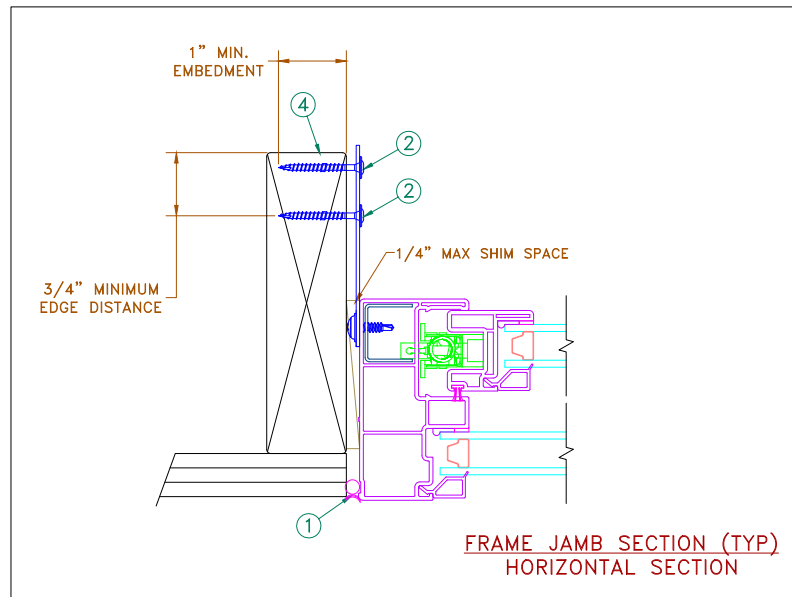

FRAME JAMB SECTION (TYP)
HORIZONTAL SECTION

MAXIMUM FRAME	CLASS/DP	IMPACT
144" x 96"	CW/30	NO

Installation Notes:

1. Seal exterior frame to substrate using backer rod plus sealant. Sill shall be set on a continuous serpentine bead of structural grade silicone/caulk.
2. Head and Jamb must be fastened through anchor strap using (QTY 2) #10 fasteners with sufficient length to penetrate a min. 1" into wood substrate. (For 2x wood frame substrate, Min. S.G. - 0.42).
3. Sill fastener size @ back angle to wood framing is #8 @ 4" O.C.. Fastener size for sill @ back angle to window is 10-16 x 1/2"(MAX.) TEK Screw @ 4" O.C.
4. Structural framing (wood buck, stud framing and opening) to be designed and anchored to properly transfer all loads to structure. The host structure is the responsibility of the architect or engineer of the record for the project of installation

General Notes:

1. The product shown herein is designed, tested and manufactured to comply with the wind load criteria of the adopted International Building Code (IBC), the International Residential Code (IRC), the current Florida Building Code (FBC) and the industry requirement for the stated conditions.
2. All glazing shall conform to ASTM E1300.
3. At minimum, glazing shall be 3mm annealed - 13mm airspace - 3mm annealed glass.
4. Use structural or composite shims where required.
5. Anchor strap specifications: 16 Ga. galvanized steel, .060 min. thickness x .850" width.
6. Sill metal back angle material is either Aluminum 1/8" Min. or Steel 16 Ga. Min.

This item has been digitally signed and sealed by Micah Swartz, P.E. on the date adjacent to the seal.
Printed copies of this document are not considered signed and sealed and the signature must be verified on any electronic copies

This schedule addresses only the fasteners required to anchor the unit to achieve the rated design pressure and impact performance (where applicable) up to the size limitations noted. It is not intended as a guide to the installation process and does not address the sealing consideration that may arise in different wall conditions. For the complete installation procedure, see the instructions packaged with the unit or go to www.jeld-wen.com.

DISCLAIMER:
This drawing and its contents are confidential and are not to be reproduced or copied in whole or in part or used or disclosed to others except as authorized by JELD-WEN Inc.

08/13/24
MICAH SWARTZ, P.E.
PE No. 93573
5134 Cambridge Ct.
Klamath Falls, OR 97603
(541) 363-8075

DRAWN	Bpoutre	07/30/2024
CHECKED		
APPROVED		
SIZE	B	SCALE NTS SHEET 6 of 8
PRODUCT FAMILY	591 ENDURANCE	
DRAWING ID NO.	184-6	



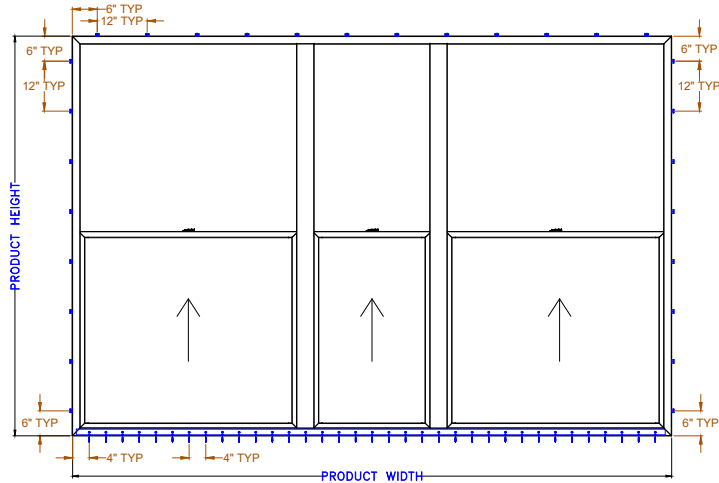

TYPICAL ELEVATION WITH FASTENER SPACING

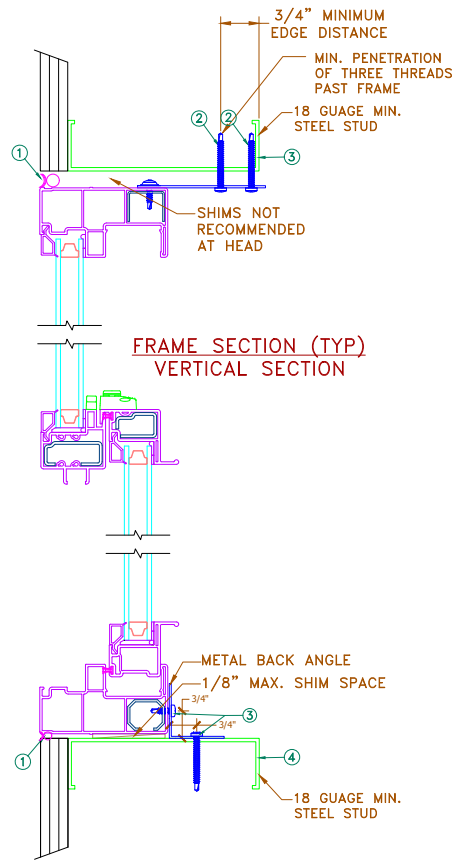

FRAME SECTION (TYP)
VERTICAL SECTION

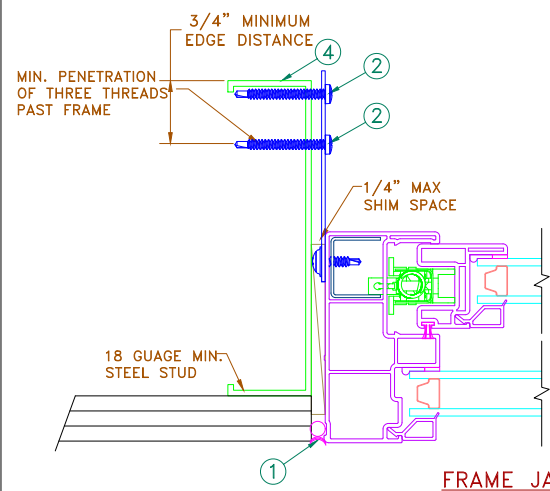

FRAME JAMB SECTION (TYP)
HORIZONTAL SECTION

NO FLANGE/MASONRY STRAP
STEEL/SCREW INSTALLATION

MAXIMUM FRAME	CLASS/DP	IMPACT
144" x 96"	CW/30	NO

Installation Notes:

1. Seal exterior frame to substrate using backer rod plus sealant. Sill shall be set on a continuous serpentine bead of structural grade silicone/caulk.
2. Head and Jamb must be fastened through anchor strap using (QTY 2) #10 TEK Screws Min Fy = 33 KSI.
3. Sill fastener size @ back angle to wood framing is 10-16 TEK Screw @ 4" O.C.. Fastener size for sill @ back angle to window is 10-16 x 1/2"(MAX.) TEK Screw @ 4" O.C.
4. Structural framing (wood buck, stud framing and opening) to be designed and anchored to properly transfer all loads to structure. The host structure is the responsibility of the architect or engineer of the record for the project of installation

General Notes:

1. The product shown herein is designed, tested and manufactured to comply with the wind load criteria of the adopted International Building Code (IBC), the International Residential Code (IRC), the current Florida Building Code (FBC) and the industry requirement for the stated conditions.
2. All glazing shall conform to ASTM E1300.
3. At minimum, glazing shall be 3mm annealed - 13mm airspace - 3mm annealed glass.
4. Use structural or composite shims where required.
5. Anchor strap specifications: 16 Ga. galvanized steel, .060 min. thickness x .850" width.
6. Sill metal back angle material is either Aluminum 1/8" Min. or Steel 16 Ga. Min.

This item has been digitally signed and sealed by Micah Swartz, P.E. on the date adjacent to the seal.
Printed copies of this document are not considered signed and sealed and the signature must be verified on any electronic copies

This schedule addresses only the fasteners required to anchor the unit to achieve the rated design pressure and impact performance (where applicable) up to the size limitations noted. It is not intended as a guide to the installation process and does not address the sealing consideration that may arise in different wall conditions. For the complete installation procedure, see the instructions packaged with the unit or go to www.jeld-wen.com.

DISCLAIMER:
This drawing and its contents are confidential and are not to be reproduced or copied in whole or in part or used or disclosed to others except as authorized by JELD-WEN Inc.

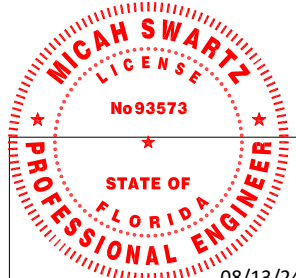

08/13/24
MICAH SWARTZ, P.E.
PE No. 93573
5134 Cambridge Ct.
Klamath Falls, OR 97603
(541) 363-8075

DRAWN	Bpoutre			07/30/2024
CHECKED				
APPROVED				
SIZE	B	SCALE	NTS	SHEET 7 of 8
PRODUCT FAMILY	591 ENDURANCE			
DRAWING ID NO.	184-7			



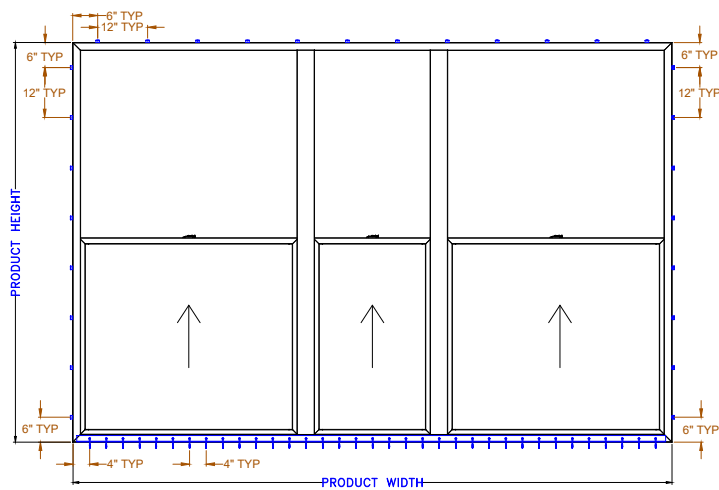

TYPICAL ELEVATION WITH FASTENER SPACING

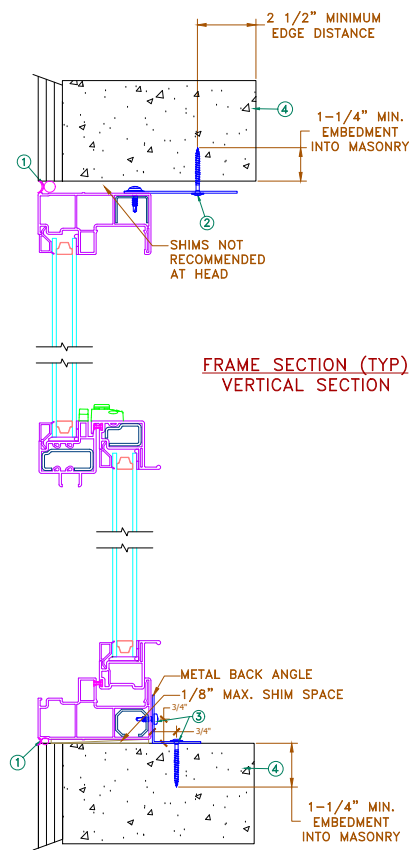

FRAME SECTION (TYP) VERTICAL SECTION

NO FLANGE/MASONRY STRAP CONCRETE SCREW INSTALLATION

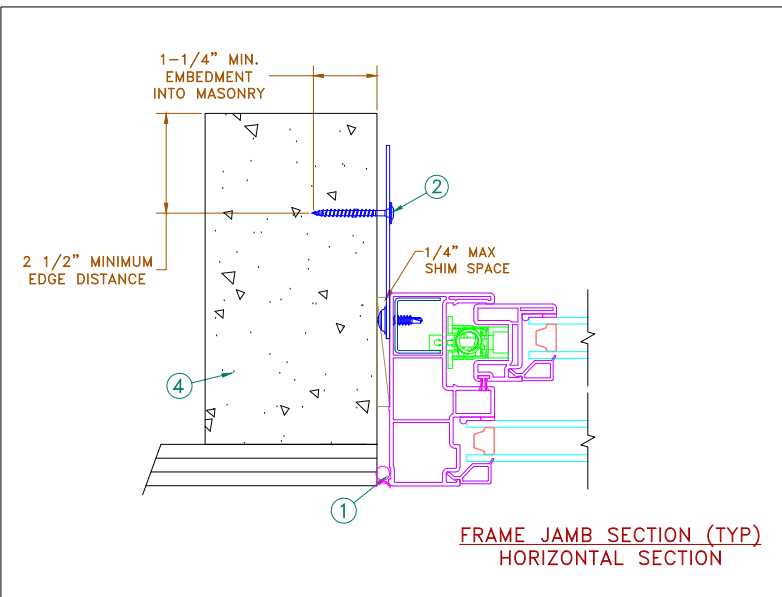

FRAME JAMB SECTION (TYP) HORIZONTAL SECTION

MAXIMUM FRAME	CLASS/DP	IMPACT
144" x 96"	CW/30	NO

Installation Notes:

1. Seal flange/frame to substrate. Sill shall be set on a continuous serpentine bead of structural grade silicone/caulk.
2. Head and Jamb must be fastened through anchor strap using one (1) 1/4"Ø Tapcon or equivalent fastener through masonry strap with sufficient length to penetrate a minimum of 1-1/4" into masonry substrate with a 2-1/2" minimum edge distance. CMU shall adhere to ASTM C90 and concrete shall have a min. F'c=3,000 PSI.
3. Sill fastener to be 3/16" Tapcon @ 4" O.C. through back angle with sufficient length to penetrate 1-1/4" into masonry substrate with a 2-1/2" min. edge distance. CMU shall adhere to ASTM C90 and concrete shall have a Min. F'c=3,000 PSI. Fastener size for sill @ back angle to window is 10-16 x 1/2"(MAX.) TEK Screw @ 4" O.C.
4. Structural framing (wood buck, stud framing and opening) to be designed and anchored to properly transfer all loads to structure. The host structure is the responsibility of the architect or engineer of the record for the project of installation

General Notes:

1. The product shown herein is designed, tested and manufactured to comply with the wind load criteria of the adopted International Building Code (IBC), the International Residential Code (IRC), the current Florida Building Code (FBC) and the industry requirement for the stated conditions.
2. All glazing shall conform to ASTM E1300.
3. At minimum, glazing shall be 3mm annealed - 13mm airspace - 3mm annealed glass.
4. Use structural or composite shims where required.
5. Anchor strap specifications: 16 Ga. galvanized steel, .060 min. thickness x .850" width.
6. Sill metal back angle material is either Aluminum 1/8" Min. or Steel 16 Ga. Min.

This item has been digitally signed and sealed by Micah Swartz, P.E. on the date adjacent to the seal.
 Printed copies of this document are not considered signed and sealed and the signature must be verified on any electronic copies

This schedule addresses only the fasteners required to anchor the unit to achieve the rated design pressure and impact performance (where applicable) up to the size limitations noted. It is not intended as a guide to the installation process and does not address the sealing consideration that may arise in different wall conditions. For the complete installation procedure, see the instructions packaged with the unit or go to www.jeld-wen.com.

DISCLAIMER:
 This drawing and its contents are confidential and are not to be reproduced or copied in whole or in part or used or disclosed to others except as authorized by JELD-WEN Inc.

08/13/24
 MICAH SWARTZ, P.E.
 PE No. 93573
 5134 Cambridge Ct.
 Klamath Falls, OR 97603
 (541) 363-8075

DRAWN	BPoutre	08/12/2024
CHECKED		
APPROVED		
SIZE	B	SCALE NTS SHEET 8 of 8
PRODUCT FAMILY	591 ENDURANCE	
DRAWING ID NO.	184-8	

